

LISTA DE RECAMBIOS / DIBUJO

**MAQUINA FLEJADORA PARA FLEJE
DE PLASTICO CON ACUMULADOR
MODELO P328 A/A**

43.2632.01

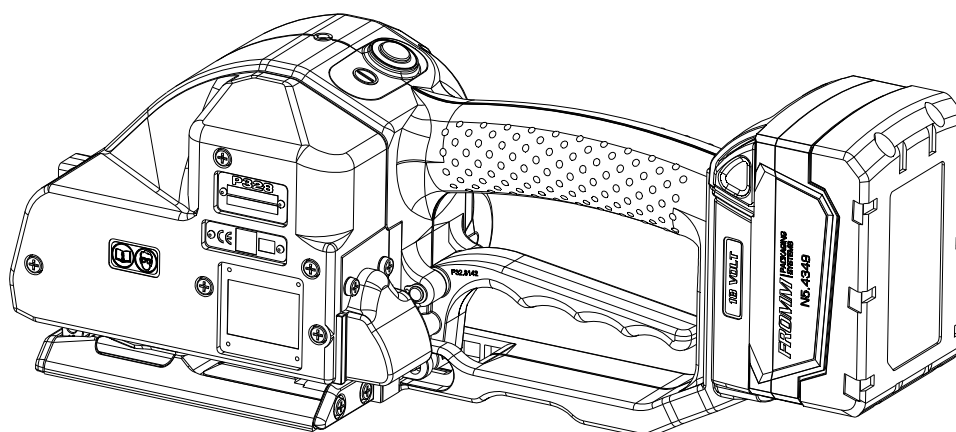

	Índice	Página
1	Lista de recambios 43.2632.01	2
2	Dibujo 43.2632.01	6

1 Lista de recambios 43.2632.01

43.2632.01	P328/13/0.65-1.05/A		P328.0002.01			23.04.2020
Art.n°		en grupo	Pcs.	Descripción	Medidas	Campo
N1.1196			3	TORNILLO	M4 X 16	D6
N1.1305			6	TORNILLO	M4 X 7.8	C2+
N1.1553		P32.1250	1	TORNILLO DE CABEZA HEXAGONAL	M4 X 8	B12
N1.1910			2	TORNILLO CILINDRICO	M4 X 12	B10
N1.1911			2	TORNILLO CILINDRICO	M4 X 8	A3
N1.1927		P32.0217	1	TORNILLO CILINDRICO	M4 X 60	D19
N1.1928			1	TORNILLO CILINDRICO	M4 X 16	B6
N1.1934			1	TORNILLO CILINDRICO	M4 X 50	B6
N1.1934		P32.0217	2	TORNILLO CILINDRICO	M4 X 50	D19
N1.1943			2	TORNILLO CILINDRICO	M4 X 40	B6
N1.1966		P32.0217	1	TORNILLO	M4 X 70	C19
N1.1972		P32.0217	1	TORNILLO	M4 X 78	D19
N1.1973			1	TORNILLO CILINDRICO	M4 X 10	A6
N1.2188		P32.0205	3	TORNILLO AVELLANADO	M4 X 16	D13
N1.2222			2	TORNILLO AVELLANADO	M4 X 10	C1
N1.2239		P32.0208	3	TORNILLO AVELLANADO	M4 X 20	D14
N1.6305		P32.0217	1	ANILLO DISTANCIADOR	6 X 18 X 0.5	B24
N1.6331		P32.0217	3	ANILLO DISTANCIADOR	6 X 12 X 0.5	B9+
N1.6386		P32.0217	1	ANILLO DISTANCIADOR	9 X 15 X 0.50	D17
N1.6504			18	ARANDELA DE SEGURIDAD	M4	C1+
N1.6504		P32.0217	5	ARANDELA DE SEGURIDAD	M4	C19+
N1.6504		P32.1250	1	ARANDELA DE SEGURIDAD	M4	B12
N1.7207		P32.0217	1	TORNILLO PT	3 X 40	C20
N1.7211		P32.0217	8	TORNILLO PT	3 X 20	C19+
N1.7222		P32.0217	1	TORNILLO PT	2.2 X 5	B21
N2.1118		P32.0217	2	ANILLO DE SEGURIDAD	6	B9+
N2.1121			1	ANILLO DE SEGURIDAD	5	B12
N2.1121		P32.0217	4	ANILLO DE SEGURIDAD	5	D10+
N2.1606		P32.0217	1	ANILLO ELAST.DE RET.	SW6	C19
N2.1610		P32.0208	1	ANILLO ELAST.DE RET.	SB44	C14
N2.2110		P32.0200	1	PASADOR CILINDRICO	4 m6 X 10	D8
N2.2119		P32.0222	1	PASADOR CILINDRICO	4 m6 X 18	D4
N2.2124			1	PASADOR CILINDRICO	4 m6 X 40	C2
N2.2126		P32.0207	1	PASADOR CILINDRICO	5 m6 X 26	B15
N2.2142		P32.0206	1	PASADOR CILINDRICO	4 m6 X 28	C16
N2.2145		P32.0205	3	PASADOR CILINDRICO	4 h6 X 18	C14
N2.2147		P32.0200	2	PASADOR CILINDRICO	3 m6 X 10	C2
N2.2180		P32.0208	1	PASADOR CILINDRICO	4 m6 X 16	C16
N2.2187		P32.0200	1	PASADOR CILINDRICO	3 m6 X 6	C9
N2.2190		P32.0217	1	PASADOR CILINDRICO	6 h6 X 18	C18
N2.2193			1	PASADOR CILINDRICO	3 m6 X 32	C12
N2.2443		P32.0203	1	PASADOR DE SUJECION	4 X 15	A8
N2.3364		P32.0217	1	RESORTE DE AJUSTE	2 X 2 X 6	C7
N2.4902			2	TORN.CON CAB.DE MART.	1.85 X 4.76	A6
N2.4902		P32.0221	2	TORN.CON CAB.DE MART.	1.85 X 4.76	A6
N2.5157		P32.0217	2	RESORTE DE COMPRESIÓN	0.6 X 4.8 X 20/15.5	B8
N2.5178			2	RESORTE DE COMPRESIÓN	0.32X2.82X20.5/20.5	C12
N2.5237			1	RESORTE DE COMPRESIÓN	0.8 X 4.8 X 25/18.5	C11
N2.5296		P32.0208	1	RESORTE DE COMPRESIÓN	0.5 X 4 X 24/16.5	C16
N21.2140		P32.0217	1	PASADOR DE SUJECION	2 X 16	D7

[] = Grupo

* = Piezas con desgaste

43.2632.01	P328/13/0.65-1.05/A			P328.0002.01		23.04.2020
Art.n°		en grupo	Pcs.	Descripción	Medidas	Campo
N21.2144		P32.0217	1	PASADOR CILINDRICO	3 h6 X 30	B16
N21.2145		P32.0207	3	PASADOR CILINDRICO	5 h6 X 37.3	B3
N21.5124		P32.0217	1	RESORTE DE COMPRESIÓN	0.9 X 10 X 15/5.5	B19
N21.5138		P32.0203	1	RESORTE DE COMPRESIÓN	2.5 X 14.2 X 33.5/7.5	A8
N21.5139		P32.0217	1	RESORTE DE COMPRESIÓN	1.25 X 9.8 X 45/14.5	B15
N21.5219		P32.0217	1	RESORTE DE COMPRESIÓN	0.43 X 3.6 X 32.9/27.5	B13
N3.1134		P32.0202	1	RODAMIENTO DE BOLAS	7 X 22 X7	A15
N3.1134		P32.0217	1	RODAMIENTO DE BOLAS	7 X 22 X7	B16
N3.1159		P33.0204	1	RODAMIENTO DE BOLAS	6 X 19 X 6	B17
N3.1172			2	RODAMIENTO DE BOLAS	30 X 42 X 7	B3+
N3.1178		P32.0204	1	RODAMIENTO DE BOLAS	35 X 44 X 5	B15
N3.1185			1	RODAMIENTO DE BOLAS	5 X 16 X 5	C5
N3.1185		P32.0208	1	RODAMIENTO DE BOLAS	5 X 16 X 5	D16
N3.1702		P32.0217	6	BOLA	4 MM	C10
N3.2105		P32.0205	3	COJINETE DE AGUJAS	K 4 X 7 X 7 TN	C14
N3.2107			3	COJINETE DE AGUJAS	K 5 X 9 X 13 TN	B4
N3.2347		P32.0144	2	CASQUILLO DE AGUJAS	10 X 14 X 12	A15+
N3.2362		P32.0210	1	CASQUILLO DE AGUJAS	6 X 10 X 8	B24
N3.3150		P32.0222	1	COJIN.DE DESLIZAM.	8 X 10 X 12	D5
N3.3172		P32.0207	1	COJIN.DE DESLIZAM.	8 X 10 X 10	B17
N3.4509	*	P32.0209	1	AGUJAS A RUEDA LIBRE	6 X 10 X 15	D17
N3.4509	*	P32.0212	1	AGUJAS A RUEDA LIBRE	6 X 10 X 15	D21
N3.4520	*	P32.0211	1	PINON LIBRE	6 X 10 X 12	D22
N31.1118		P32.0217	2	RODAMIENTO DE BOLAS	10 X 19 X 5	B22
N31.1120		P32.0205	1	RODAMIENTO DE BOLAS	4 X 11 X 4	C14
N31.1120		P32.0217	1	RODAMIENTO DE BOLAS	4 X 11 X 4	C22
N31.1151		P32.0217	1	RODAMIENTO DE BOLAS	17 X 30 X 7	D22
N31.1163		P32.0212	1	RODAMIENTO DE BOLAS	15 X 24 X 5	D21
N31.1169		P32.0205	1	RODAMIENTO DE BOLAS	40 X 50 X 6	D16
N31.3115		P32.0200	1	COJIN.DE DESLIZAM.	6 X 8 X 6	B9
N4.3236		P32.0217	1	CORREA DENTADA	9 MM	A23
N4.9159		P32.0221	1	ETIQUETA	<<CE>>	A6
N41.9127		P32.0221	1	ETIQUETA	20 X 10 X 0.1	B5
N43.9164		P32.8196	1	ETIQUETA	WEEE	C19
N43.9192		P32.8103	1	ETIQUETA	18 Volt	A22
N43.9192		P32.8196	1	ETIQUETA	18 Volt	B19
N44.9104		P32.8196	1	ETIQUETA	<<FROMM>>	D21
N44.9170		P32.8196	1	ETIQUETA		D19
N44.9185			1	ETIQUETA		A6
N44.9190		P32.8103	1	ETIQUETA		A22
N5.2382		P32.8154	1	MICRO INTERRUPTOR		C23
N5.2702			1	TAPA		C20
N51.1127		P32.0217	1	MOTOR REDUCTOR		A21
N51.2194		P32.0216	1	PIEZA DE INSERTATION		A19
N51.2199		N51.1111	3	TAPON ROSCADO		C22
N51.5477		P32.8103	1			A22
N6.6224		P32.0217	2	ANILLO-O	24 X 2	C21
N6.6232		P32.0217	1	ANILLO-O	8 X 2	A20
N61.6220		P32.0217	2	ANILLO-O	29.5 X 3	D23
P30.1210		P32.8151	1	SOPORTE		C20
P31.1124		P32.0200	1	TUBO		B14
[P32.0144]		P32.0217	1	BASCULA		B15

[] = Grupo

* = Piezas con desgaste

43.2632.01	P328/13/0.65-1.05/A		P328.0002.01		23.04.2020	
Art.n°	en grupo	Pcs.	Descripción		Medidas	Campo
P32.0149		P32.0217	1	PINON		C22
[P32.0200]		P32.0217	1	CAJA		A1+
[P32.0202]		P32.0217	1	EXCENTRICA SOLDADOR		A14
[P32.0203]		P32.0217	1	HUSILLO		A7
[P32.0204]		P32.0208	1	RUEDA DENTADA		B14
[P32.0205]		P32.0208	1	ESCALON PLANETARIO		C13
[P32.0206]		P32.0208	1	ASIDERO		C16
[P32.0207]		P32.0208	1	CAJA ENGRANAJE		B3+
[P32.0208]		P32.0217	1	ENGRANAJE		B13
[P32.0209]		P32.0217	1	RUEDA DENTADA		C17
[P32.0210]		P32.0217	1	RUEDA DENTADA		B23
[P32.0211]		P32.0217	1	PINON		D23
[P32.0212]		P32.0217	1	RUEDA DENTADA		D21
P32.0213	*	P32.0217	1	MOTOR		D21
[P32.0216]		P32.0217	1	ELECTRONICA		B21
[P32.0217]			1	MODELO BASE		D6+
[P32.0221]			1	TAPA		A4
[P32.0222]			1	PLANCHA DEL COJINETE		D4
P32.1022		P32.0202	1	EXCENTRICA SOLDADOR		A15
P32.1024		P32.0144	1	BASCULA		A16
P32.1027		P32.0217	1	COJINETE DE BOLAS		C10
P32.1028		P32.0217	1	PERNO		D11
P32.1029		P32.0217	1	PIEZA DE PRESION		C10
P32.1032		P32.0217	1	PERNO DE ARRASTRE		D11
P32.1035		P32.0217	2	ARRASTRADOR		D10+
P32.1215		P32.0217	1	EYE DE ASIDERO		C19
[P32.1250]			1	PASADOR		C12
P32.1251		P32.1250	1	PASADOR		B12
P32.1252		P32.1250	1	PIEZA DE PRESION		B12
P32.1511	*	P32.0217	1	MORDAZA DE SOLDADURA		D11
P32.1710			1	CASQUILLO DE CENTRAJE		C12
P32.2009		P32.8151	2	BOTON GIRATORIO CON RAYA		C20
P32.2012		P32.0217	1	GUIA		B16
P32.2016		P33.0204	1	RUEDA DENTADA		C17
P32.8101		P32.0200	1	CAJA		C7
[P32.8103]		P32.0217	1	CAJA DE MOTOR		A22
P32.8106			1	PIEZAS INTERCALADA DE ACERO		D9
P32.8107	*		1	BALIZA DE SOLDADURA		C10
P32.8108			1	SOPORTE DE LA MORDAZA		C3
P32.8109	*		1	MORDAZA DE SUJECCION		D3
P32.8110	*		1	MORDAZA DE SUJECCION		D3
P32.8111	*		1	MORDAZA DE SUJECCION		D3
P32.8115		P32.0202	1	PINON		A14
P32.8116		P32.0203	1	CORREDERA DEL RESORTE		A9
P32.8117		P32.0203	1	HUSILLO		B8
P32.8118			1	PLACA DE GUIA CINTA		A3
P32.8120		P32.0217	1	IMAN		D7
P32.8121		P32.0217	1	ARBOL EXCENTRICO		C7
P32.8122		P32.0217	1	POLEA PARA CORREA TRAPEZOIDAL		B9
P32.8125		P32.0217	1	PASADOR		B14
P32.8126		P32.0204	1	RUEDA DENTADA		C15
P32.8127		P32.0205	1	PORTAPINON		C14

[] = Grupo

* = Piezas con desgaste

43.2632.01	P328/13/0.65-1.05/A		P328.0002.01		23.04.2020
Art.n°	en grupo	Pcs.	Descripción	Medidas	Campo
P32.8128		P32.0205	1	RUEDA DENTADA	C13
P32.8129		P32.0208	1	RUEDA DENTADA	D16
P32.8130		P32.0206	1	ASIDERO	C16
P32.8131		P32.0207	1	CAJA ENGRANAJE	C17
P32.8132		P32.0208	1	TAPA DE ENGRANAJE	D15
P32.8133		P32.0217	1	PASADOR	C23
P32.8134		P32.0209	1	RUEDA DENTADA	D17
P32.8135		P32.0210	1	RUEDA DENTADA	B24
P32.8136		P32.0217	1	CAJA	B24
P32.8137		P32.0200	1	EJE	A18
P32.8138		P32.0211	1	PINON	D22
P32.8139		P32.0212	1	RUEDA DENTADA	D21
P32.8140		P32.0217	1	SOPORTE	A22
P32.8141		P32.0217	1	CUBIERTA	B21
P32.8142		P32.0217	1	ASIDERO	B21
[P32.8151]		P32.0216	1	ELECTRONICA	B20
[P32.8154]		P32.0217	1	CONMUTADOR	A21
P32.8158		P32.0221	1	TAPA	A4
P32.8159		P32.0222	1	PLANCHA DEL COJINETE	C5
P32.8164			1	TOPE DE CINTA	B1
P32.8174			1	GUIA CINTA	D4
P32.8179			1	CAJA DE GUIA	B11
P32.8185			1	PERNO DE GUIA	D12
P32.8193			1	PERNO DE GUIA	D12
P32.8195			1	TAPA	C9
[P32.8196]		P32.0217	1	CAJA DE MOTOR	B19
[P33.0204]		P32.0217	1	RUEDA DENTADA	B18
P33.2115		P32.8151	1	BOTON GIRATORIO CON RAYA	C20
P33.2127		N51.1111	3	TUBO FLEXIBLE	C22
P33.2145		P32.0217	1	DISCO	B21
P33.2155		P32.0217	1	VAINA	C22
P35.3104		P32.0205	3	RUEDA DE PINON	C13
P35.3201			3	RUEDA DE PINON	B4
P35.3203	*		1	ROLLO DE TENSOR	C4
P35.3214	*		1	CHUCHILLA	C11
P35.3220			1	ASIDERO BASCULANTE	B11
P35.3221			1	ASIDERO BASCULANTE	C12

[] = Grupo

* = Piezas con desgaste

2 Dibujo 43.2632.01

