

SPARE PARTS LIST / DRAWINGS

**BATTERY - POWERED  
PLASTIC STRAPPING TOOL  
MODEL P331 M/HA**

43.0294.01

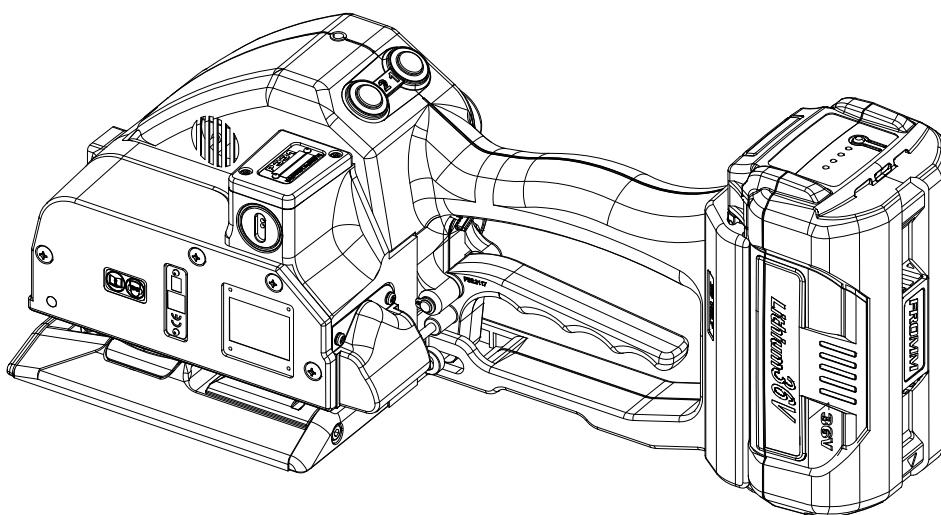

	<b>Index</b>	<b>Page</b>
<b>1</b>	<b>Spare parts list 43.0294.01</b>	<b>2</b>
<b>2</b>	<b>Drawing 43.0294.01</b>	<b>6</b>

# 1 Spare parts list 43.0294.01

43.0294.01	P331/32/0.80-1.19/7.0		P331.0001.01			21.04.20
Item-No.		in group	Pcs.	Description	Dimension	Field
N1.1168			3	SCREW	M5 X 16	D6
N1.1305			6	SCREW	M4 X 7.8	C1+
N1.1553		P35.0227	1	HEXAGON SCREW	M4 X 8	B12
N1.1919			1	SCREW	M4 X 16	A6
N1.1924			1	SCREW	M4 X 65	B6
N1.1927		P33.0212	1	FLAT HEAD SCREW	M4 X 60	D19
N1.1932			2	FLAT HEAD SCREW	M3 X 8	A10
N1.1932		P33.0212	2	FLAT HEAD SCREW	M3 X 8	B9
N1.1934		P33.0212	3	FLAT HEAD SCREW	M4 X 50	D19
N1.1965			2	SCREW	M4 X 45	B6
N1.1966		P33.0212	1	SCREW	M4 X 70	D19
N1.2189		P35.0214	3	COUNTERSUNK SCREW	M4 X 20	D13
N1.2212		P33.0208	4	COUNTERSUNK SCREW	M4 X 25	D14
N1.2222			2	COUNTERSUNK SCREW	M4 X 10	C1
N1.6331		P33.0212	3	SPACER WASHER	6 X 12 X 0.5	A23+
N1.6384		P33.0208	1	SPACER WASHER	11 X 17 X 0.5	C17
N1.6503			3	SAFETY WASHER	M5	D5
N1.6504			12	SAFETY WASHER	M4	C1+
N1.6504		P33.0212	5	SAFETY WASHER	M4	D19+
N1.6504		P35.0227	1	SAFETY WASHER	M4	B12
N1.6505			2	SAFETY WASHER	M3	A9
N1.6505		P33.0212	2	SAFETY WASHER	M3	C9
N1.7211		P33.0212	9	PT-SCREW	3 X 20	C19+
N1.7221		P33.0212	2	PT-SCREW	2.5 X 14	C22
N11.1116			2	SCREW	M4 X 12	A3
N2.1118		P33.0212	2	SECURITY RING	6	A23+
N2.1121			1	SECURITY RING	5	B12
N2.1121		P33.0212	1	SECURITY RING	5	C9
N2.1606		P33.0212	1	SPRING RING	SW6	C19
N2.1614		P33.0208	1	SPRING RING		C14
N2.2110		P33.0201	1	PARALLEL PIN	4 m6 X 10	D8
N2.2119		P35.0226	1	PARALLEL PIN	4 m6 X 18	D4
N2.2147		P33.0201	2	PARALLEL PIN	3 m6 X 10	C2
N2.2149		P33.0212	1	PARALLEL PIN	4 h6 X 22	B16
N2.2162			2	PARALLEL PIN	3 m6 X 24	B11+
N2.2165		P33.0206	1	PARALLEL PIN	4 m6 X 34	C16
N2.2172		P33.0207	1	PARALLEL PIN	5 m6 X 30	B15
N2.2187		P33.0201	1	PARALLEL PIN	3 m6 X 6	C8
N2.2190		P33.0212	1	PARALLEL PIN	6 h6 X 18	C18
N2.2443		P33.0203	1	DOWEL PIN	4 X 15	A7
N2.2465		P33.0212	1	DOWEL PIN	1.5 X 8	A23
N2.3364		P33.0212	1	FEATHER KEY	2 X 2 X 6	A24
N2.4902			4	HAMMER HEAD BOLT	1.85 X 4.76	B5+
N2.5157		P33.0212	2	PRESSURE SPRING	0.6 X 4.8 X 20/15.5	B8
N2.5178			2	PRESSURE SPRING	0.32X2.82X20.5/20.5	C12
N2.5296		P33.0208	1	PRESSURE SPRING	0.5 X 4 X 24/16.5	C16
N21.2106		P33.0207	3	PARALLEL PIN	8 h6 X 50	B3
N21.2130		P35.0214	3	PARALLEL PIN	5 h6 X 20	C14
N21.5124		P33.0212	1	PRESSURE SPRING	0.9 X 10 X 15/5.5	A20
N21.5207		P33.0212	1	PRESSURE SPRING	0.5 X 4.5 X 31/20.5	B14

[ ] = Group

\* = Wearing parts

43.0294.01	P331/32/0.80-1.19/7.0		P331.0001.01			21.04.20
Item-No.		in group	Pcs.	Description	Dimension	Field
N21.5211			1	PRESSURE SPRING	0.75 X 4.5 X 24/15.5	C11
N21.5216		P33.0203	1	PRESSURE SPRING	2.8 X 15 X 34.5/7.5	B8
N21.5217		P33.0212	1	PRESSURE SPRING	1.25 X 9.5 X 46.5/15.5	B15
N3.1134		P33.0202	1	BALL BEARING	7 X 22 X7	A15
N3.1134		P33.0212	1	BALL BEARING	7 X 22 X7	A16
N3.1159		P33.0204	1	BALL BEARING	6 X 19 X 6	B17
N3.1160		P35.0213	1	BALL BEARING	40 X 52 X 7	B15
N3.1174			1	BALL BEARING	7 X 19 X 6	C5
N3.1702		P33.0212	6	BALL	4 MM	C10
N3.2106		P35.0214	3	NEEDLE CAGE	K 5 X 8 X 10 TN	C14
N3.2111			6	NEEDLE CAGE	K 8 X 11 X 10 TV	B3
N3.2347		P35.0202	2	NEEDLE BUSH	10 X 14 X 12	A15+
N3.3103		P35.0226	1	SLIDE-BEARING	10 X 12 X 20	D5
N3.3166		P33.0207	1	SLIDE-BEARING	10 X 12 X 12	B17
N3.3189		P33.0201	1	SLIDE-BEARING	8 X 10 X 8	C7
N3.3318		P33.0205	1	SLIDE-BEARING	8 X 10 X 4	D16
N3.4509	*	P33.0209	1	NEEDLE FREE WHEELING	6 X 10 X 15	D23
N3.4509	*	P33.0210	1	NEEDLE FREE WHEELING	6 X 10 X 15	C21
N3.4519		P35.0217	1	FREE-WHEELING	8 X 12 X 22	C17
N31.1118		P33.0212	2	BALL BEARING	10 X 19 X 5	C23
N31.1120		P33.0212	1	BALL BEARING	4 X 11 X 4	C22
N31.1121		P35.0218	1	BALL BEARING	45 X 58 X 7	D16
N31.1145		P35.0214	1	BALL BEARING	45 X 55 X 6	C14
N31.1148			2	BALL BEARING	40 X 52 X 7	B3+
N31.1151		P33.0212	2	BALL BEARING	17 X 30 X 7	D23
N31.1163		P33.0210	1	BALL BEARING	15 X 24 X 5	D21
N31.3111		P33.0201	1	SLIDE-BEARING	20 X 23 X 10	C9
N4.9159			1	LABEL	<<CE>>	B5
N43.9181			1	ADHESIVE LABEL	20 X 10 X 0.1	B5
N44.9104		P33.2113	1	ADHESIVE LABEL	<<FROMM>>	D21
N44.9139		P33.2111	1	ADHESIVE LABEL	36V	A22
N44.9139		P33.2113	1	ADHESIVE LABEL	36V	B19
N44.9140		P33.2113	1	ADHESIVE LABEL		D19
N44.9185			1	TYPE PLATE		A10
N44.9191		P33.2111	1	ADHESIVE LABEL		A22
N5.1193	*	P33.0212	1	GEAR MOTOR		B20
N5.2702		P33.0212	1	COVER		D20
N51.2129		P33.2008	1	CONTACT PLUG		B20
N51.2129		P33.2010	1	CONTACT PLUG		B20
N51.2199		N51.1110	3	CONTACT PLUG		C22
N51.5464		P33.0212	1	FAN		C23
N51.5477		P33.2111	1	SPRING PIN		B22
N6.6224		P33.0212	2	O-RING	24 X 2	C21
N6.6232		P33.0212	1	O-RING	8 X 2	B20
N61.6220		P33.0212	4	O-RING	29.5 X 3	D23
P31.1124		P33.0201	1	TUBE		B14
P32.1022		P33.0202	1	WELDING EXCENTRIC		A15
P32.1027		P33.0212	1	BALL CAGE		C10
P32.1029		P33.0212	1	THRUST PIECE		C10
P32.1251		P35.0227	1	PUSHER		B12
P32.2009		P33.2116	2	TURNING BUTTON		C20
P32.2012		P33.0212	1	GUIDE		B16

[ ] = Group

\* = Wearing parts

43.0294.01	P331/32/0.80-1.19/7.0		P331.0001.01		21.04.20	
Item-No.		in group	Pcs.	Description	Dimension	Field
P32.2016		P33.0204	1	GEAR WHEEL		B18
[P33.0201]		P33.0212	1	BODY		B7
[P33.0202]		P33.0212	1	WELDING EXCENTRIC		A15
[P33.0203]		P33.0212	1	SPRING BOLT		B7
[P33.0204]		P33.0212	1	GEAR WHEEL		B18
[P33.0205]		P33.0208	1	GEARING COVER		C15
[P33.0206]		P33.0208	1	LEVER		C16
[P33.0207]		P33.0208	1	GEAR BODY		B17
[P33.0208]		P33.0212	1	GEAR		B14+
[P33.0209]		P33.0212	1	CONICAL GEAR WHEEL		D23
[P33.0210]		P33.0212	1	GEAR WHEEL		C22
P33.0211	*	P33.0212	1	MOTOR		D22
[P33.0212]			1	BASE MODEL		D6+
P33.1236			1	GUIDE PIN		D12
P33.1237			1	GUIDE PIN		D12
P33.2102		P33.0201	1	BODY		D7
P33.2103		P33.0201	1	BOLT		A18
P33.2104		P33.0202	1	PINION		A15
P33.2105		P33.0203	1	SPRING BOLT		B8
P33.2106		P33.0203	1	SPRING SLIDE		A8
P33.2107		P33.0212	1	RETAINER		A23
P33.2108		P33.0205	1	GEARING COVER		D15
P33.2109		P33.0207	1	GEAR BODY		B16
[P33.2111]		P33.0212	1	MOTOR HOUSING		A22
[P33.2113]		P33.0212	1	MOTOR HOUSING		B19
P33.2115		P33.2116	1	TURNING BUTTON		C20
[P33.2116]		P33.0212	1	CIRCUIT BOARD	36V	B21
P33.2117		P33.0212	1	HANDLE LEVER		B21
P33.2118		P33.0212	1	TOUCH CONTACT-SWITCH		A21
P33.2122		P33.0209	1	CONICAL GEAR WHEEL		D23
P33.2123		P33.0210	1	GEAR WHEEL		C21
P33.2124		P33.0212	1	CONICAL GEAR WHEEL		C22
P33.2127		N51.1110	3	SHRINKABLE HOSE		C22
P33.2130		P33.0212	1	ECCENTRIC SHAFT		C9
P33.2131		P33.0212	1	GEAR WHEEL		A23
P33.2132		P33.0212	1	COVER		B9
P33.2133		P33.0212	1	PUSHER		B14
P33.2135		P33.0212	1	INSERT PART		A20
P33.2136		P33.0212	1	COVER		A20
P33.2137		P33.0212	1	HANDLE SHAFT		C19
P33.2140			1	STEEL INSERT		D9
P33.2142			1	CENTERING SLEEVE		C12
P33.2143			1	COVER		A4
P33.2145		P33.0212	1	DISK		B22
P33.2150			1	STRAP GUIDE		D4
P33.2155		P33.0212	1	DOWEL		C22
P33.2229	*		1	TENSIONING WHEEL		C4
[P35.0202]		P33.0212	1	ROCKER		A15
[P35.0213]		P33.0208	1	GEAR WHEEL		B15
[P35.0214]		P33.0208	1	WHEEL		C13
[P35.0217]		P33.0208	1	RATCHET WHEEL		C17
[P35.0218]		P33.0208	1	GEAR WHEEL		D16

[ ] = Group

\* = Wearing parts

43.0294.01	P331/32/0.80-1.19/7.0			P331.0001.01		21.04.20
Item-No.		in group	Pcs.	Description	Dimension	Field
[P35.0226]			1	END COVER		D4
[P35.0227]			1	PUSHER		B12
P35.4104	*		1	WELDING STOP GRIPPER		D9
P35.4105			1	STRAP GUIDE PLATE		A3
P35.4106		P35.0202	1	ROCKER		A16
P35.4107	*	P33.0212	1	WELDING GRIPPER		D10
P35.4110		P33.0212	1	DRIVING PIN		C11
P35.4111		P33.0212	2	DRIVER		D10+
P35.4150		P35.0213	1	GEAR WHEEL		B15
P35.4151		P35.0214	1	GEAR WHEEL		C13
P35.4154		P35.0214	1	PLANET SHAFT		C14
P35.4155		P35.0214	3	PINION		C13
P35.4156		P33.0206	1	LEVER		C16
P35.4159		P35.0217	1	GEAR WHEEL		C17
P35.4160		P35.0218	1	GEAR WHEEL		D16
P35.4184			1	HOLDER		C3
P35.4185	*		1	GRIPPER		D3
P35.4186	*		1	GRIPPER		D3
P35.4187	*		1	GRIPPER		D3
P35.4192			1	STRAP STOP		B1
P35.4196			3	PINION		B4
P35.4197		P35.0226	1	END COVER		D4
P35.4198	*		1	CUTTER		C11
P35.4199			1	GUIDE		C11
P35.4201			1	GUIDE CASE		C12
P35.4203			1	SEESAW LEVER		C12
P35.4204			1	SEESAW LEVER		B11
P35.4205		P35.0227	1	THRUST PIECE		B12
P35.4210		P33.0212	1	BOLT		D11
P35.4213			1	COVER		C9

[ ] = Group

\* = Wearing parts

2 Drawing 43.0294.01

