

LISTADO DE PIEZAS DE RECAMBIO / DIBUJOS
**FLEJADORA NEUMÁTICA PARA
FLEJE DE PLÁSTICO
MODELO P358**

49.0262.01

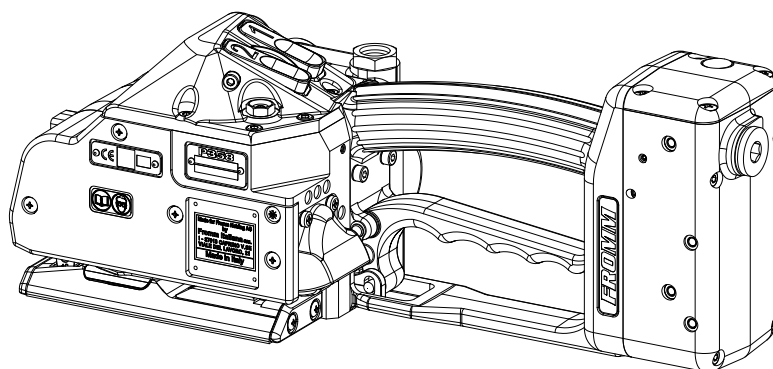

ÍNDICE

PÁGINA

1	LISTA DE RECAMBIOS 49.0262.01	2
2	DIBUJO 49.0262.01	8

1 LISTA DE RECAMBIOS 49.0262.01

49.0262.01	P358/16/0.65-1.05/4.0		P358.0001.01			21.12.17
Art.n°		en grupo	Pcs.	Descripción	Medidas	Campo
N1.1196			3	TORNILLO	M4 X 16	D17
N1.1305		P35.0352	6	TORNILLO	M4 X 7.8	C14+
N1.1553		P35.0146	1	TORNILLO DE CABEZA HEXAGONAL	M4 X 8	D14
N1.1816		P35.0323	4	TORNILLO GOTA DE SEBO	M4 X 16	B25
N1.1910			2	TORNILLO CILINDRICO	M4 X 12	D16
N1.1911		P35.0352	2	TORNILLO CILINDRICO	M4 X 8	C14
N1.1928			1	TORNILLO CILINDRICO	M4 X 16	D18
N1.1930		P35.0315	1	TORNILLO CILINDRICO	M3 X 4	C4
N1.1934			1	TORNILLO CILINDRICO	M4 X 50	D18
N1.1936			1	TORNILLO CILINDRICO	M4 X 45	D18
N1.1943			2	TORNILLO CILINDRICO	M4 X 40	D18
N1.2151		P35.0315	2	TORNILLO AVELLANADO	M4 X 10	B1
N1.2163		P35.0325	2	TORNILLO AVELLANADO	M5 X 12	E9
N1.2163		P35.0352	1	TORNILLO AVELLANADO	M5 X 12	D22
N1.2188		P35.0340	3	TORNILLO AVELLANADO	M4 X 16	B21
N1.2222			2	TORNILLO AVELLANADO	M4 X 10	B17
N1.2239		P35.0308	3	TORNILLO AVELLANADO	M4 X 20	A22
N1.3128		P35.0352	1	VARILLA ROSCADA	M4 X 8	D1
N1.5105		P35.0325	2	TUERCA	M8	D10
N1.5602		P35.0304	1	TUERCA RANURADA	M10 X 1	A14
N1.6331		P35.0352	2	ANILLO DISTANCIADOR	6 X 12 X 0.5	C15+
N1.6504			10	ARANDELA DE SEGURIDAD	M4	C16+
N1.6504		P35.0146	1	ARANDELA DE SEGURIDAD	M4	D14
N1.6504		P35.0318	2	ARANDELA DE SEGURIDAD	M4	A7+
N1.6504		P35.0323	4	ARANDELA DE SEGURIDAD	M4	D24+
N1.6504		P35.0352	23	ARANDELA DE SEGURIDAD	M4	D2+
N11.1174		P35.0352	2	TORNILLO	M4 X 30	D2
N11.1179		P35.0352	7	TORNILLO	M4 X 12	A7
N12.1153		P35.0323	4	TORNILLO CILINDRICO	M4 X 50	D23
N12.1153		P35.0352	2	TORNILLO CILINDRICO	M4 X 50	D1+
N12.1168		P35.0352	4	TORNILLO CILINDRICO	M4 X 20	D20+
N2.1118		P35.0352	1	ANILLO DE SEGURIDAD	6	D21
N2.1121			1	ANILLO DE SEGURIDAD	5	D14
N2.1121		P35.0352	4	ANILLO DE SEGURIDAD	5	C11+
N2.1301		P35.0211	1	ANILLO DE SEGURIDAD	6	F23+
N2.1601		P35.0319	1	ANILLO ELAST.DE RET.	SW12	D24
N2.1606		P35.0316	1	ANILLO ELAST.DE RET.	SW6	D8
N2.1606		P35.0352	1	ANILLO ELAST.DE RET.	SW6	C21
N2.1610		P35.0308	1	ANILLO ELAST.DE RET.	SB44	A21
N2.2101		P35.0323	1	PASADOR CILINDRICO	5 m6 X 12	E25
N2.2101		P35.0352	3	PASADOR CILINDRICO	5 m6 X 12	B5+
N2.2110		P35.0301	1	PASADOR CILINDRICO	4 m6 X 10	C13
N2.2110		P35.0352	1	PASADOR CILINDRICO	4 m6 X 10	B9
N2.2112		P35.0308	1	PASADOR CILINDRICO	3 m6 X 12	B22
N2.2114		P35.0318	1	PASADOR CILINDRICO	4 m6 X 24	B9
N2.2119		P32.0222	1	PASADOR CILINDRICO	4 m6 X 18	C17
N2.2124			1	PASADOR CILINDRICO	4 m6 X 40	B17
N2.2145		P35.0340	3	PASADOR CILINDRICO	4 h6 X 18	B20
N2.2147		P35.0301	2	PASADOR CILINDRICO	3 m6 X 10	C19
N2.2172		P35.0305	1	PASADOR CILINDRICO	5 m6 X 30	A20

[] = Grupo

* = Piezas con desgaste

49.0262.01	P358/16/0.65-1.05/4.0			P358.0001.01		21.12.17
Art.n°		en grupo	Pcs.	Descripción	Medidas	Campo
N2.2180		P35.0335	1	PASADOR CILINDRICO	4 m6 X 16	B20
N2.2187		P35.0301	1	PASADOR CILINDRICO	3 m6 X 6	C13
N2.2190		P35.0352	1	PASADOR CILINDRICO	6 h6 X 18	C15
N2.2193			1	PASADOR CILINDRICO	3 m6 X 32	D14
N2.2401		P35.0311	1	PASADOR DE SUJECION	3 X 10	B3
N2.2406		P35.0312	1	PASADOR DE SUJECION	2.5 X 14	A2
N2.4902			2	TORN.CON CAB.DE MART.	1.85 X 4.76	C18
N2.4902		P35.0324	2	TORN.CON CAB.DE MART.	1.85 X 4.76	C18
N2.5157		P35.0352	2	RESORTE DE COMPRESIÓN	0.6 X 4.8 X 20/15.5	B14
N2.5178			2	RESORTE DE COMPRESIÓN	0.32X2.82X20.5/20.5	D13
N2.5237			1	RESORTE DE COMPRESIÓN	0.8 X 4.8 X 25/18.5	D13
N2.5291		P35.0352	1	RESORTE DE COMPRESIÓN	0.55 X 3.6 X 40/33.5	C20
N2.5296		P35.0308	1	RESORTE DE COMPRESIÓN	0.5 X 4 X 24/16.5	B21
N2.5604		P35.0315	2	RESORTE DE DISCO	31.5 X 16.3 X 1.25	C2+
N2.5623		P35.0325	2	RESORTE DE DISCO	20 X 8.2 X 1/1.55	D10
N21.2145		P35.0305	3	PASADOR CILINDRICO	5 h6 X 37.3	B19
N21.5212		P35.0204	1	RESORTE DE COMPRESIÓN	0.5 X 3.7 X 26.5/18.5	D7
N21.5212		P35.0316	1	RESORTE DE COMPRESIÓN	0.5 X 3.7 X 26.5/18.5	E8
N21.5212		P35.0317	1	RESORTE DE COMPRESIÓN	0.5 X 3.7 X 26.5/18.5	B9
N21.5213		P35.0211	1	RESORTE DE COMPRESIÓN	0.32 X 8.5 X 17/6.5	F24
N21.5225		P35.0352	1	RESORTE DE COMPRESIÓN	1.25 X 19.1 X 68/8.5	A14
N21.5226		P35.0352	1	RESORTE DE COMPRESIÓN	1.25 X 9.5 X 47/16.5	A20
N21.5227		P35.0319	1	RESORTE DE COMPRESIÓN	0.9 X 8.0 X 47.5/17.5	D24
N21.5228		P35.0320	1	RESORTE DE COMPRESIÓN	0.5 X 3.4 X 40/35.5	D23
N21.5232		P35.0352	1	RESORTE DE COMPRESIÓN	0.75 X 6.0 X 38.8/17.5	C5
N3.1172			2	RODAMIENTO DE BOLAS	30 X 42 X 7	C18+
N3.1174		P35.0302	1	RODAMIENTO DE BOLAS	7 X 19 X 6	B15
N3.1174		P35.0315	1	RODAMIENTO DE BOLAS	7 X 19 X 6	A3
N3.1174		P35.0352	1	RODAMIENTO DE BOLAS	7 X 19 X 6	B15
N3.1178		P32.0204	1	RODAMIENTO DE BOLAS	35 X 44 X 5	A21
N3.1185			1	RODAMIENTO DE BOLAS	5 X 16 X 5	C18
N3.1702		P35.0352	10	BOLA	4 MM	D1+
N3.2105		P35.0340	3	COJINETE DE AGUJAS	K 4 X 7 X 7 TN	B21
N3.2107			3	COJINETE DE AGUJAS	K 5 X 9 X 13 TN	B18
N3.2347		P35.0303	2	CASQUILLO DE AGUJAS	10 X 14 X 12	C13
N3.3150		P32.0222	1	COJIN.DE DESLIZAM.	8 X 10 X 12	C17
N3.3172		P35.0305	1	COJIN.DE DESLIZAM.	8 X 10 X 10	B20
N3.3331		P35.0343	1	COJIN.DE DESLIZAM.	6 X 8 X 3	B22
N3.4509	*	P35.0313	1	AGUJAS A RUEDA LIBRE	6 X 10 X 15	B1
N3.4520	*	P35.0306	1	PINON LIBRE	6 X 10 X 12	A20
N3.4520	*	P35.0314	1	PINON LIBRE	6 X 10 X 12	A4
N31.1118		P35.0315	2	RODAMIENTO DE BOLAS	10 X 19 X 5	C4
N31.1120		P35.0340	1	RODAMIENTO DE BOLAS	4 X 11 X 4	B20
N31.1135		P35.0315	1	RODAMIENTO DE BOLAS	15 X 24 X 7	A3
N31.1150		P35.0315	1	RODAMIENTO DE BOLAS	8 X 19 X 6	C2
N31.1163		P35.0313	1	RODAMIENTO DE BOLAS	15 X 24 X 5	C1
N31.1169		P35.0340	1	RODAMIENTO DE BOLAS	40 X 50 X 6	B21
N31.1177		P35.0308	1	RODAMIENTO DE BOLAS	4 X 13 X 5	B22
N31.1178		P35.0309	1	RODAMIENTO DE BOLAS	6 X 17 X 6	C16
N31.1184		P35.0306	1	RODAMIENTO DE BOLAS	6 X 12 X 3	A20
N31.1185		P35.0306	1	RODAMIENTO DE BOLAS	6 X 10 X 2.5	A20
N4.5137		P35.0352	3	TAPA DE PROTECCION		F23+

[] = Grupo

* = Piezas con desgaste

49.0262.01	P358/16/0.65-1.05/4.0		P358.0001.01		21.12.17
Art.n°	en grupo	Pcs.	Descripción	Medidas	Campo
N4.9159	P35.0324	1	ETIQUETA	<<CE>>	C18
N41.9127	P35.0324	1	ETIQUETA	20 X 10 X 0.1	D19
N41.9129	P35.0352	1	ETIQUETA	p max. 6 bar/87 psi	C2
N44.9104	P35.0323	2	ETIQUETA	<<FROMM>>	F25+
N44.9104	P35.0352	1	ETIQUETA	<<FROMM>>	D2
N44.9181		1	ETIQUETA	<<P358>>	B18
N6.3223	P35.0318	1	VISUALIZACIÓN DE PRESIÓN		B7
N6.3407	P35.0304	1	PISTON	40 X 8	A14
N6.5136	P35.0323	1	TAPON ROSCADO		D24
N6.6117	P35.0204	3	GUARNICION	6 X 13 X 2.3	C7+
N6.6117	P35.0316	2	GUARNICION	6 X 13 X 2.3	C8+
N6.6117	P35.0317	3	GUARNICION	6 X 13 X 2.3	B9+
N6.6117	P35.0319	4	GUARNICION	6 X 13 X 2.3	A24+
N6.6117	P35.0320	5	GUARNICION	6 X 13 X 2.3	A23+
N6.6123	P35.0319	2	GUARNICION	12 X 19 X 2.3	C24
N6.6157	P35.0211	1	ANILLO DE EMPAQUETADURA	4 MM	E24+
N6.6163	P35.0310	1	GUARNICION	10 X 13.6 X 2.3	B5
N6.6208	P35.0316	3	ANILLO-O	14 X 2	C8+
N6.6209	P35.0319	6	ANILLO-O	17 X 2	A24+
N6.6209	P35.0320	6	ANILLO-O	17 X 2	A23+
N6.6209	P35.0323	1	ANILLO-O	17 X 2	A23
N6.6211	P35.0315	2	ANILLO-O	16 X 2	C3
N6.6214	P35.0313	2	ANILLO-O	23 X 2	C1
N6.6214	P35.0315	3	ANILLO-O	23 X 2	A3+
N6.6217	P35.0352	2	ANILLO-O	15 X 2	C3
N6.6235	P35.0310	2	ANILLO-O	12 X 2	B5
N6.6247	P35.0316	1	ANILLO-O	5 X 2.5	C8
N6.6247	P35.0321	1	ANILLO-O	5 X 2.5	C26
N6.6256	P35.0322	1	ANILLO-O	5.5 X 1.5	D25
N6.6267	P35.0321	3	ANILLO-O	10 X 2.0	C26+
N6.6267	P35.0323	1	ANILLO-O	10 X 2.0	C26
N6.6268	P35.0310	1	ANILLO-O	6 X 2.5	B5
N6.6283	P35.0211	1	ANILLO-O	4 X 1	F24
N6.6283	P35.0301	1	ANILLO-O	4 X 1	C6
N6.6283	P35.0322	1	ANILLO-O	4 X 1	D25
N6.6291	P35.0204	3	ANILLO-O	11.5 X 1.5	C7+
N6.6291	P35.0317	3	ANILLO-O	11.5 X 1.5	B9+
N6.6299	P35.0352	1	ANILLO-O	29 X 2	D3
N6.6706	P35.0315	2	DIAFRAGMA		C3
N61.5606	P35.0352	1	MANGUITO DE REDUCCION		C2
N61.6107	P35.0320	1	ANILLO DE EMPAQUETADURA	12 X 7 X 2	C23
N61.6208	P35.0211	2	ANILLO-O	9.5 X 1.5	E23+
N61.6219	P35.0352	1	ANILLO-O	7 X 2	B5
N61.6234	P35.0315	2	ANILLO-O	39 X 1.5	A2+
N61.6235	P35.0318	1	ANILLO-O	35 X 2.5	C7
[P32.0204]	P35.0308	1	RUEDA DENTADA		A21
[P32.0222]		1	PLANCHA DEL COJINETE		C17
P32.1027	P35.0352	1	COJINETE DE BOLAS		B12
P32.1028	P35.0352	1	PERNO		D12
P32.1029	P35.0352	1	PIEZA DE PRESION		B12
P32.1032	P35.0352	1	PERNO DE ARRASTRE		D12
P32.1035	P35.0352	2	ARRASTRADOR		C11+

[] = Grupo

* = Piezas con desgaste

49.0262.01	P358/16/0.65-1.05/4.0		P358.0001.01		21.12.17	
Art.n°		en grupo	Pcs.	Descripción	Medidas	Campo
P32.1251		P35.0146	1	POSADOR		D14
P32.1511	*	P35.0352	1	MORDAZA DE SOLDADURA		C12
P32.1710			1	CASQUILLO DE CENTRAJE		D14
P32.8106		P35.0352	1	PIEZAS INTERCALADA DE ACERO		B13
P32.8107	*	P35.0352	1	BALIZA DE SOLDADURA		B13
P32.8108		P35.0352	1	SOPORTE DE LA MORDAZA		A18
P32.8109	*	P35.0352	1	MORDAZA DE SUJECCION		A18
P32.8110	*	P35.0352	1	MORDAZA DE SUJECCION		A19
P32.8111	*	P35.0352	1	MORDAZA DE SUJECCION		A19
P32.8118		P35.0352	1	PLACA DE GUIA CINTA		C14
P32.8126		P32.0204	1	RUEDA DENTADA		A21
P32.8127		P35.0340	1	PORTAPINON		B20
P32.8159		P32.0222	1	PLANCHA DEL COJINETE		C17
P32.8168			1	TOPE DE CINTA		B17
P32.8177			1	GUIA CINTA		B17
P32.8302		P35.0325	1	ESTRIBO DE SUSPENSION		D9
[P35.0146]			1	POSADOR		D15
[P35.0204]		P35.0352	1	VALVULA		E7
[P35.0211]		P35.0323	2	VALVULA DE MARIPOSA		E23+
[P35.0301]		P35.0352	1	CAJA		B19
[P35.0302]		P35.0352	1	EXCENTRICA SOLDADOR		B15
[P35.0303]		P35.0352	1	BASCULA		C13
[P35.0304]		P35.0352	1	PISTON		A13
[P35.0305]		P35.0308	1	CAJA ENGRANAJE		B20
[P35.0306]		P35.0308	1	RUEDA DENTADA		A20
[P35.0308]		P35.0352	1	ENGRANAJE		A22
[P35.0309]		P35.0352	1	RUEDA DENTADA		C16
[P35.0310]		P35.0352	1	PALANCA REGULADORA		C6
[P35.0311]		P35.0315	1	PLACA DE COJINETE		B3
[P35.0312]		P35.0315	1	PLACA DE COJINETE		B1
[P35.0313]		P35.0315	1	RUEDA DENTADA		C1
[P35.0314]		P35.0315	1	PINON		A4
[P35.0315]		P35.0352	1	MOTOR		A1
[P35.0316]		P35.0352	1	VALVULA		C9
[P35.0317]		P35.0318	1	VALVULA		B10
[P35.0318]		P35.0352	1	TAPA		A9
[P35.0319]		P35.0323	1	VALVULA		A25
[P35.0320]		P35.0323	1	VALVULA		A23
[P35.0321]		P35.0323	1	VALVULA		C25
[P35.0322]		P35.0323	1	TORNILLO DE MARIPOSA		D25
[P35.0323]		P35.0352	1	ASIDERO		F25
[P35.0324]			1	TAPA		D19
[P35.0325]			1	ESTRIBO DE SUSPENSION		E10
[P35.0335]		P35.0308	1	ASIDERO		B20
[P35.0340]		P35.0308	1	ESCALON PLANETARIO		C21
[P35.0343]		P35.0308	1	TAPA DE ENGRANAJE		A22
[P35.0352]			1	MODELO BASE		D5+
P35.1317		P35.0321	1	COMPUERTA DE VALVULA		C26
P35.1344		P35.0352	1	PESTILLO REGULADOR		D1
P35.1350		P35.0321	1	CONTRAVAINA		D26
P35.2058		P35.0211	1	CUERPO DEL OBTURADOR		E24+
P35.2060		P35.0211	1	TORNILLO DE MARIPOSA		F23+

[] = Grupo

* = Piezas con desgaste

49.0262.01	P358/16/0.65-1.05/4.0		P358.0001.01		21.12.17	
Art.n°		en grupo	Pcs.	Descripción	Medidas	Campo
P35.2069		P35.0325	2	DISCO DE MUESCAS		E10
P35.2073		P35.0325	1	DISCO		D10
P35.3104		P35.0340	3	RUEDA DE PINON		B21
P35.3143		P35.0204	2	ANILLO DE SOPORTE		D7
P35.3143		P35.0317	2	ANILLO DE SOPORTE		B9+
P35.3158		P35.0323	1	DISCO		D24
P35.3201			3	RUEDA DE PINON		B18
P35.3203	*		1	ROLLO DE TENSOR		C17
P35.3214	*		1	CHUCHILLA		D13
P35.3215			1	CAJA DE GUIA		D13
P35.3216			1	PERNO DE GUIA		D14
P35.3217			1	PERNO DE GUIA		D14
P35.3220			1	ASIDERO BASCULANTE		C14
P35.3221			1	ASIDERO BASCULANTE		D13
P35.3223		P35.0146	1	PIEZA DE PRESION		D14
P35.4112		P35.0204	1	POSADOR		D7
P35.4113		P35.0204	1	ANILLO DE SALIDA DE AIRE		C7
P35.4114		P35.0204	1	GUIA		D7
P35.4114		P35.0317	1	GUIA		B9
P35.4119		P35.0316	1	POSADOR		D8
P35.4121		P35.0317	1	VAINA		C10
P35.4122		P35.0317	1	BULON		C10
P35.4145		P35.0211	1	ALOJAMIENTO DEL OBTURADOR		E24+
P35.4162		P35.0310	1	ANILLO FINAL		B5
P35.4163		P35.0310	1	VAINA DE VALVULA		B5
P35.4172		P35.0315	2	DISCO DE SOPORTE		C2+
P35.4176		P35.0315	2	SOPORTE		C3
P35.4180		P35.0352	2	CRIBA		C3
P35.4182		P35.0352	2	AMORTIGUADOR		C3
P35.4207		P35.0352	1	CABEZA DE CONTROL		D1
P35.5101		P35.0324	1	TAPA		C19
P35.5102			1	TAPA		C16
P35.5103		P35.0301	1	CAJA		B20
P35.5104		P35.0301	1	EJE		C18
P35.5105		P35.0302	1	PINON		C15
P35.5106		P35.0302	1	EXCENTRICA SOLDADOR		B15
P35.5107		P35.0303	1	BASCULA		C13
P35.5108		P35.0304	1	VASTAGO DE EMBOLO		A14
P35.5109		P35.0352	1	TUBO		C20
P35.5110		P35.0352	1	POSADOR		C20
P35.5111		P35.0301	1	BOQUILLA		C6
P35.5112		P35.0305	1	CAJA ENGRANAJE		A20
P35.5113		P35.0308	1	RUEDA DENTADA		B21
P35.5115		P35.0306	1	RUEDA DENTADA		A20
P35.5116		P35.0309	1	RUEDA DENTADA		C15
P35.5117		P35.0352	1	SOPORTE DE COJINETE		C15
P35.5118		P35.0352	1	PLANCHA DE EMPAQUETADURAS MODO		C5
P35.5119		P35.0310	1	PALANCA REGULADORA		C5
P35.5122		P35.0311	1	PLACA DE COJINETE		B3
P35.5123		P35.0312	1	PLACA DE COJINETE		A2
P35.5124		P35.0315	1	CAMISA		B3
P35.5125	*	P35.0315	8	LAMINAS		B1

[] = Grupo

* = Piezas con desgaste

49.0262.01	P358/16/0.65-1.05/4.0		P358.0001.01		21.12.17
Art.n°	en grupo	Pcs.	Descripción	Medidas	Campo
P35.5126	P35.0315	1	ROTOR		B3
P35.5127	P35.0313	1	RUEDA DENTADA		B1
P35.5128	P35.0313	1	TAPA		B1
P35.5129	P35.0314	1	PINON		A4
P35.5130	P35.0315	1	PINON		C4
P35.5131	P35.0352	1	CRIBA		D4
P35.5132	P35.0352	1	AMORTIGUADOR		D3
P35.5133	P35.0352	1	TAPA		D3
P35.5134	P35.0315	1	CAJA DE MOTOR		C5
P35.5135	P35.0352	1	PLANCHA DE EMPAQUETADURAS MODO		E9
P35.5136	P35.0352	1	VALVULA DE MARIPOSA		E9
P35.5137	P35.0316	1	ANILLO DE VALVULA		C8
P35.5138	P35.0316	1	ANILLO DE SOPORTE		C8
P35.5139	P35.0316	1	ANILLO DE SOPORTE		D8
P35.5140	P35.0316	1	DISCO		D8
P35.5141	P35.0318	1	TAPA		B8
P35.5142	P35.0318	1	ASIDERO		C7
P35.5143	P35.0318	1	ASIDERO		B7
P35.5144	P35.0318	2	EJE		A7+
P35.5145	P35.0352	1	PLANCHA DE EMPAQUETADURAS MODO		C21
P35.5146	P35.0323	1	ASIDERO		D22+
P35.5147	P35.0323	1	CAJA DE VALVULA		E25
P35.5148	P35.0319	1	ANILLO FINAL		C24
P35.5149	P35.0319	1	ANILLO DE SOPORTE		C24
P35.5150	P35.0319	1	ANILLO DE SOPORTE		C24
P35.5151	P35.0319	1	ANILLO DE SOPORTE		B24
P35.5151	P35.0320	1	ANILLO DE SOPORTE		A23
P35.5152	P35.0319	2	ANILLO DE SOPORTE		A24+
P35.5152	P35.0320	1	ANILLO DE SOPORTE		B23
P35.5153	P35.0319	1	ANILLO INTERMEDIO		A24
P35.5154	P35.0319	1	COMPUERTA DE VALVULA		D24
P35.5155	P35.0320	1	CILINDRO		D23
P35.5156	P35.0320	1	ANILLO INTERMEDIO		C23
P35.5157	P35.0320	2	ANILLO DE SOPORTE		B23+
P35.5158	P35.0320	1	ANILLO FINAL		A23
P35.5159	P35.0320	1	COMPUERTA DE VALVULA		C23
P35.5160	P35.0321	1	VAINA DE VALVULA		C26
P35.5161	P35.0323	1	TAPA		C26
P35.5162	P35.0323	1	PLANCHA DE EMPAQUETADURAS MODO		F25
P35.5163	P35.0322	1	TORNILLO DE MARIPOSA		D25
P35.5164	P35.0352	1	DISCO		D22
P35.5165	P35.0352	1	ASIDERO		D21
P35.5166	P35.0352	1	EYE DE ASIDERO		C21
P35.5169	P35.0325	1	BRIDA		E9
P35.5190	P35.0340	1	RUEDA DENTADA		B21
P35.5191	P35.0335	1	ASIDERO		B20
P35.5192	P35.0343	1	TAPA DE ENGRANAJE		B22
P36.1305	P35.0211	1	GUIA		E23+
P36.1306	P35.0211	1	SOPORTE DEL OBTURADOR		F23+

[] = Grupo

* = Piezas con desgaste

2 DIBUJO 49.0262.01

